

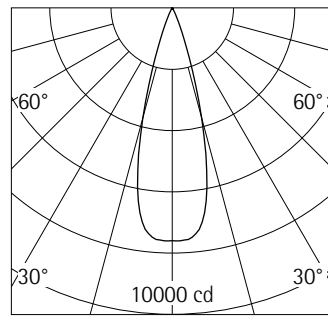

72834.000 Silver
 LED 24W 2520lm 3000K warm white
 Phase dimmable+ On-board Dim
 Version 6
 Spherolit lens, flood

Product description
 Housing and bracket: cast aluminium, powder-coated. 0°-90° tilt. Bracket on 3-circuit adapter rotatable through 360°. Internal wiring. ERCO control gear, dimmable. Rotary control for brightness regulation. 3-phase adapter for ERCO 220-240V track: polymer, black. LED module: high-power LEDs on metal-core PCB. Collimating lens made of optical polymer. Front cover: polymer, black. Dimming with external dimmers possible (trailing edge). Weight 1.30kg

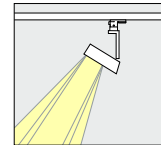
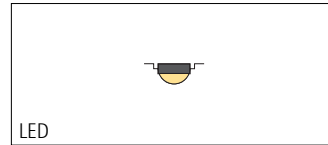
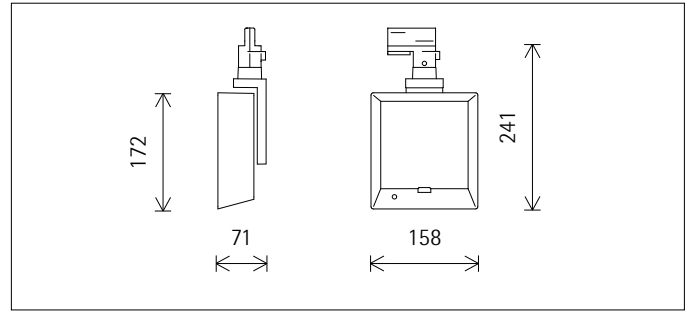

h(m)	E(lx)	D(m)
		30°
1	7597	0.54
2	1899	1.07
3	844	1.61
4	475	2.14
5	304	2.68

Technical data

Luminous flux of the luminaire	1996lm
Connected load	29.0W
Luminaire efficacy	69lm/W
Colour deviation	1.5 SDCM
Colour rendition index	CRI 92
Lumen maintenance (LED manufacturer specifications)	L90/B10 ≤50000h L90 ≤100000h
LED failure rate	0.1% ≤50000h
Dimming range	1%-100%
Dimming method	CCR_PWM
LMF	E
Energy efficiency class	EEI A+
Standby power per control gear	--
Luminaires per circuit breaker B16	112

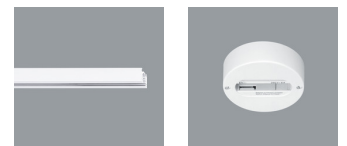

Mounting
 ERCO 3-circuit track
 Hi-trac 3-circuit track
 1-circuit singlet

For your regional contact in the ERCO
 Sales network click here
www.ercos.com/contact

Technical Region: 220-240V 50/60Hz
 We reserve the right to make technical
 and design changes.
 Edition: 21.12.2020
 Current version under
www.ercos.com/72834.000

Planning data

Cleaning (a)	1				2				3			
	P	C	N	D	P	C	N	D	P	C	N	D
LMF	0.96	0.94	0.90	0.86	0.93	0.91	0.86	0.81	0.92	0.90	0.84	0.79
RSMF	0.99	0.97	0.95	0.92	0.98	0.97	0.95	0.92	0.98	0.97	0.95	0.92

Hours of operation (h)	1000	5000	10000	20000	30000	40000	50000
LLMF	1.00	0.99	0.98	0.96	0.94	0.92	0.90
LSF	1	1	1	1	1	1	1

MF	LMFxRSMFxLLMFxLSF
MF	Maintenance Factor
LMF	Luminaire Maintenance Factor
RSMF	Room Surface Maintenance Factor
LLMF	Lamp Lumens Maintenance Factor
LSF	Lamp Survival Factor
P	Room pure
C	Room clean
N	Room normal
D	Room dirty

Technical data in accordance with international norms and standards

IEC 60598	Luminaires – Part 1+2: general requirements, specific requirements and tests
IEC 62031	LED modules for general lighting – safety requirements
IEC 62471	Photobiological safety of lamps and lamp systems
EN 13032-4	Light and lighting – measurement and representation of photometric data
CIE 13	Method of measuring and specifying colour rendering properties of light sources

All technical data is subject to industrially standard tolerances.
Also see www.erco.com/erco-led

Accessories

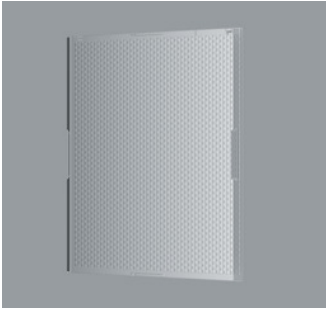

70924.000
Spherolit lens spot
made of optical polymer.
Replacement without tools.



70609.000
Snoot
Polymer.
Black

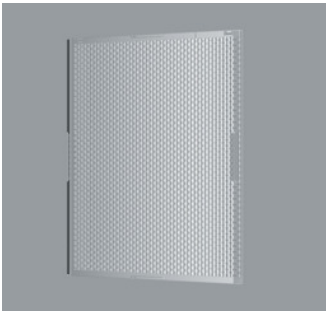

70925.000
Spherolit lens flood
made of optical polymer.
Replacement without tools.



79833.000
Snoot
Polymer.
Silver

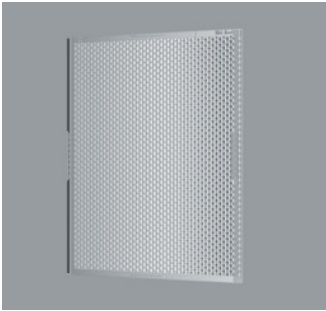

70926.000
Spherolit lens wide flood
made of optical polymer.
Replacement without tools.

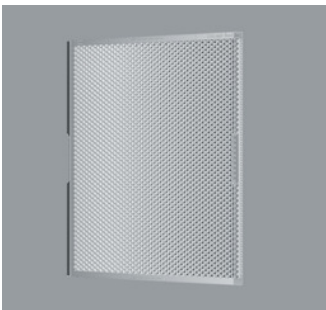

70999.000
Spherolit lens extra wide flood
made of optical polymer.
Replacement without tools.



70929.000
Spherolit lens oval flood
made of optical polymer.
Replacement without tools.

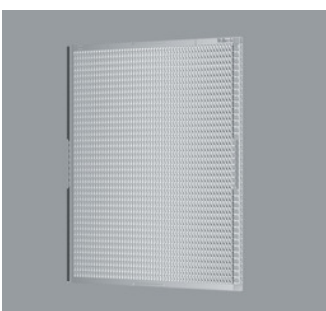

70928.000
Spherolit lens wallwash
made of optical polymer.
Replacement without tools.